



# IVAR<sup>®</sup>

## ALL-IN-ONE VMS & IVA

Intelligent Video Analytics Recorder | Version 1.11



[gorilla-technology.com](http://gorilla-technology.com)

# IMPROVED SECURITY & OPERATIONAL EFFICIENCY

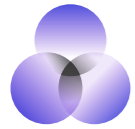

## All-in-One VMS & IVA Solution

- Comprehensive yet compact Video Management System with Intelligent Video Analytics
- Ideal for clients who prefer to take all-in-one and proactive video surveillance



## Flexible & Scalable with Client Needs

- Scalable and flexible use from all-in-one machines or gateway hubs to large server scenarios
- Well defined deployment to small shops, large sites or multiple site scenarios



## Adding Value with API Integration

Open architecture and API interface for quick integration with existing VMS solutions (e.g., Milestone XProtect®) and other platforms (e.g., IoT, Access Control, Building Automation System – BAS, Kiosk) which ensures minimal migration efforts for clients and System Integrators.



## Intel® Optimized for Cost & Performance

- Fully optimized by the OpenVINO™ toolkit to run faster and give a better cost structure when compared to CPU/GPU-based hardware
- Versatility that can run on CPU-only systems, NO GPU needed



## Make Proactive Choices Based on Actionable Insights, Not Guesswork

- Create Profiles & Dashboard Cards to View Event Data
- Gain Comprehensive and In-depth Statistical Charts that Visualize Video Data
- Gives You Actionable Insights to Enhance Operations
- Demographic, People Counting & Vehicle Counting Dashboards and Statistics Available

## IVAR® (INTELLIGENT VIDEO ANALYTICS RECORDER)

# CORE CAPABILITIES



### 1 Facial Recognition

- VIP, Watchlist, Blocklist (Requires BAP companion module)

### 2 Human Detection

- Clothing Colors
- Faces
- Head & Shoulders

### 3 Face Detection

- Gender & Age
- Eyewear
- Mask

### 4 Behavior Analysis

- Intrusion Detection
- Line Crossing
- Direction Detection
- Direction Violation
- Intelligent Behavior Analysis
- Loitering Detection
- People Counting
- Fall Detection (Depth Camera)
- Occupancy Estimation (Depth Camera)

### 5 Vehicle & License Plate Recognition

- Vehicle Type Detection
- Vehicle Counting
- Vehicle Zone Intrusion
- Vehicle Path Analysis
- Vehicle Direction Violation
- Taiwan LPR / Japan LPR

### 6 Pandemic Response Solutions

- Mask Detection
- People Flow Management
- Crowd Detection



# IVAR<sup>®</sup> ANALYTIC CAPABILITIES

IVAR<sup>®</sup> performs smoothly with Intel technologies on different edge devices and scenarios. Scale software before hardware.



## Supports

CCTV & IP-based cameras RTSP, ONVIF Profile S, & PTZ compatible H.264 transcoding.  
\* Contact Gorilla for higher camera solutions.

## EDGE

Stand-alone device locations. (E.g. POS systems, ATMs, Kiosks, etc.)

- CPU** Intel Core i3 12100
- RAM** 32GB DDR4-2133MHz
- HDD1** 256GB SSD
- HDD2** 500GB SATA (7,200RPM) or higher volume for video/event storage
- OS**
  - Windows 10 (64-bits)
  - Windows 11 (64-bits)
  - Windows server 2016/2019
  - Ubuntu 18.04 LTS (only for volume customers)

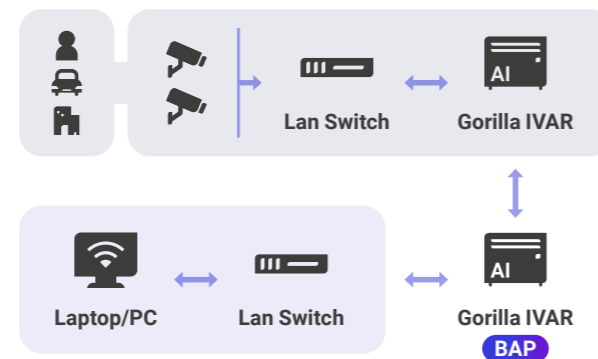

2 CH Recording, 2 CH IVA

## SERVER

Large single locations. (E.g. Hospitals, Airports, etc.)

- CPU** Intel Core i7 12700
- RAM** 32GB DDR4-2133MHz
- HDD1** 256GB SSD
- HDD2** 4TB SATA (7,200RPM) or higher volume for video/event storage
- OS**
  - Windows 10 (64-bits)
  - Windows 11 (64-bits)
  - Windows server 2016/2019
  - Ubuntu 18.04 LTS (only for volume customers)

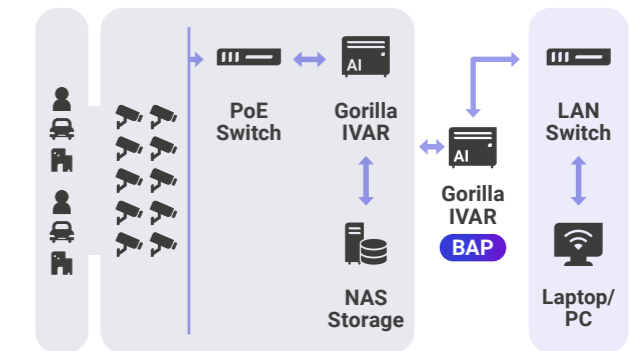

10 CH Recording, 10 CH IVA

## GATEWAY

Multiple dispersed locations. (E.g. Retail, Toll crossings, etc.)

- CPU** Intel Core i5 12600
- RAM** 32GB DDR4-2133MHz
- HDD1** 256GB SSD
- HDD2** 2TB SATA (7,200RPM) or higher volume for video/event storage
- OS**
  - Windows 10 (64-bits)
  - Windows 11 (64-bits)
  - Windows server 2016/2019
  - Ubuntu 18.04 LTS (only for volume customers)

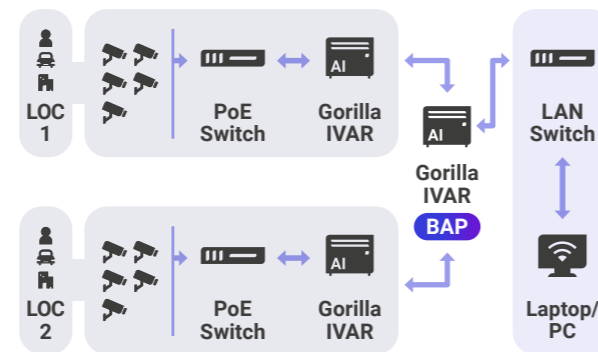

5 CH Recording, 5 CH IVA

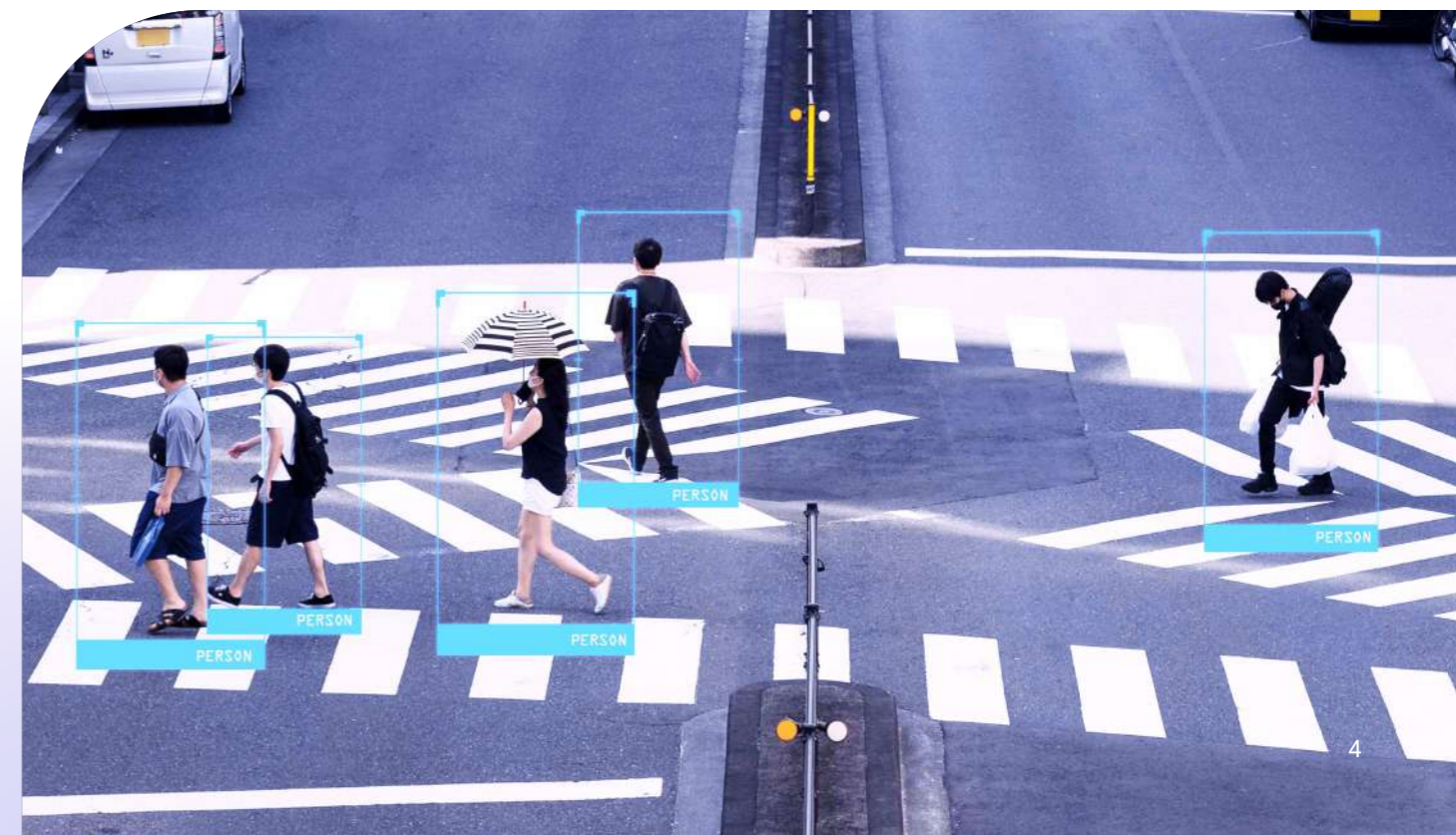

# IVAR® INTELLIGENT ARCHITECTURE

## Systems Monitoring & Control

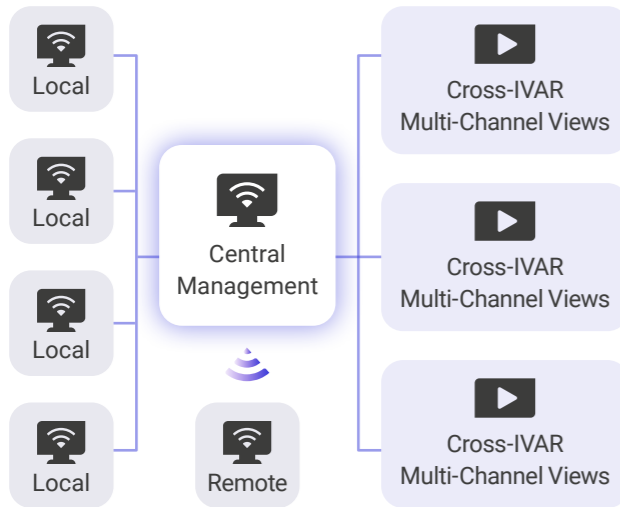

## IVA Profile Scheduling

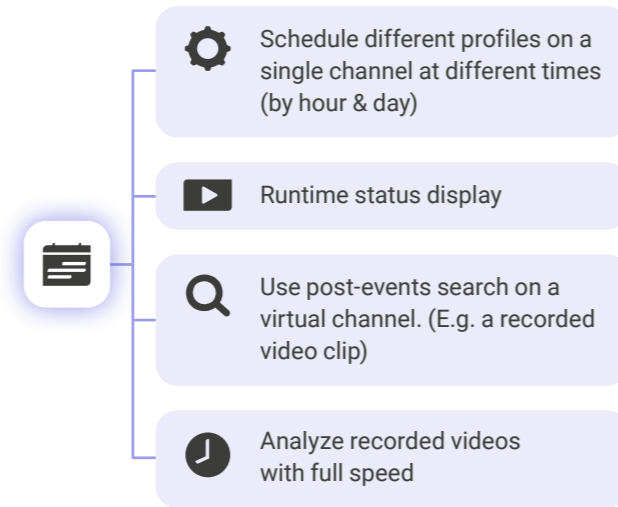

## Event Management

**Types**

- Event Panel Serial Pop-ups
- Event OSD (On Screen Display) Alerts
- On-top Event Pop-ups

**Log Export**

Real-time IVA or system events to a 3<sup>rd</sup> party web server

**Video & Event Storage**

Set minimum reserve and recycle period to avoid full disk errors

**Event View**

Snapshots of the entire camera scene, a cropped image of the captured object, event type name, and further analysis profile details

**Permission Control**

Administrators can create multiple roles with different privileges and access limitations

## API Integration

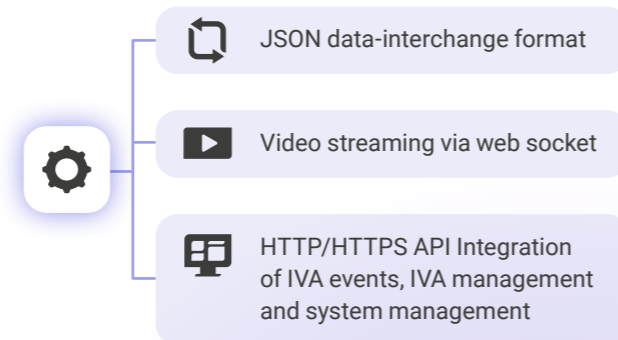

# COMPANION SOFTWARE MODULES



## BAP (Biometric Authentication Provider)

Gorilla BAP is a back-end system giving support to Gorilla IVAR®, Smart Attendance, or 3<sup>rd</sup> party applications which require facial recognition technology. It establishes and manages the face profile database, verifies face images captured by IVAR® and Smart Attendance to confirm the identity of people's faces. BAP has a face profile validation mechanism to improve the quality of face profiles to ensure the identity is correctly vouched. BAP creates an unlimited number of groups to manage face profile data to support watch lists and alerts in IVAR®. BAP's integration into IVAR® and Smart Attendance greatly increases face checks without affecting system performance.

## CUSTOMIZABLE SOLUTIONS

Add greater value to the capabilities of your system by incorporating these digital transformation solutions from Gorilla.

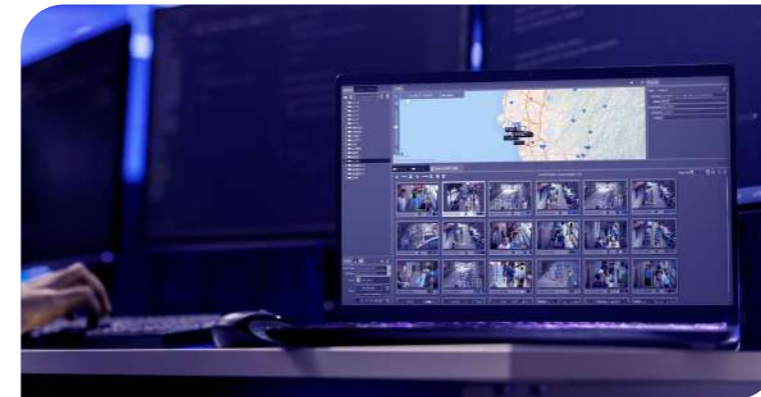

## FVS (Fast Video Search)

Quickly and easily search archived video for past events to locate detailed information on people and more.

## Network Security Products

- EdgeGuard - front-line threat detection for OT Security
- NetProbe - prevent network intrusions by learning attack patterns
- NetTrap - isolate and contain attacks before they reach your network
- HMD - supreme endpoint protection
- FR-MOTP - facial recognition with a dynamic mobile password protection
- SCP - a security convergence platform to monitor total network



**LONDON OFFICE (HEADQUARTERS)**

Meridien House, 42 Upper Berkeley Street,  
Marble Arch, London, UK W1H 5QL

**TAIPEI OFFICE**

7F, No.302, Ruey Kuang Road,  
Neihu, Taipei 114720, R.O.C

**CHENNAI OFFICE**

Josmans Complex, No. 8/5, 3rd Floor,  
MC Nichols Road, Tamil Nadu,  
Chennai-600031, India

**CAIRO OFFICE**

Cairo Festival City – Plot 12b03/B,  
First Floor, New Cairo, Cairo Egypt

**BANGKOK OFFICE**

One Bangkok Tower 4, Unit 1214, 12F,  
Witthayu Road, Lumpini, Pathum Wan,  
Bangkok 10330

**SEATTLE OFFICE**

701 Fifth Ave, Suite 4200 Seattle,  
Washington 98104



**REQUEST A DEMO**

Specifications are subject to change. Gorilla products are sold with a limited warranty.

Copyright © Gorilla Technology Group. All rights reserved.

Gorilla Technology and the Gorilla Technology logo are trademarks or registered trademarks of Gorilla Technology Group in the United States and other countries.

All other trademarks are the property of their respective owners.